

# Aesculap Surgical Instruments Unitrac®

Retraction in Perfection



The retraction and holding system for

---

Open Surgery

---

Minimal Invasive Surgery

---

Orthopaedics

---

Traumatology

---

Universal use for holding hooks, retractors, cameras and endoscopes

Extensive range of blades, hooks, camera and endoscope holders available

Pneumatically supported system for direct connection with the compressed air supply in the operating room

Required working pressure: 5.5 bar up to 12 bar

Easy to attach to operating room table

Quick sterile set-up in operating room

Autoclaveable at 134 °C (2 bar)





Das Retraktions- und Haltesystem für die

---

Offene Chirurgie

---

Minimalinvasive Chirurgie

---

Orthopädie

---

Traumatologie

---

Universell einsetzbar zum Halten von Wundhaken, Kameras und Endoskopen

Umfangreiches Zubehör an Wundhaken, Kamera- und Endoskophaltern verfügbar

Pneumatisch unterstütztes System zum direkten Anschluss an die vorhandene OP-Druckluftversorgung

Betriebsdruck: 5,5 bar bis 12 bar

Einfache Montage an die OP-Tischschiene

Schnelle und sterile Bereitstellung im OP

Dampfsterilisierbar bei 134 °C (2 bar)

---



UNITRAC®-Arm  
UNITRAC®-Arm

Order number    Dimensions  
Bestellnummer    Maße



RT040R

74 cm long  
4 kg holding force  
74 cm Länge  
4 kg Haltekraft

UNITRAC®-Arm  
UNITRAC®-Arm



One-hand-use  
Einhandbedienung

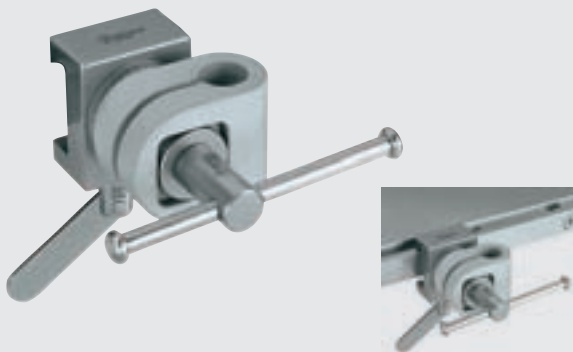

RT090R

9-10 cm width  
25-35 cm length  
9-10 cm Breite  
25-35 cm Länge



Connection to the  
OR table rail  
Adapter für OP-Schiene



FF280R

Flexible fixation element  
with ball and socket joint  
for easy attachment to  
operating table  
Flexibles Fixierelement mit  
Kugelgelenk zur Montage an  
die OP-Tisch-Schiene

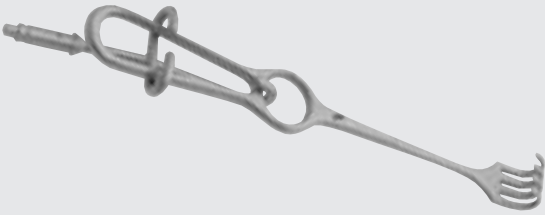
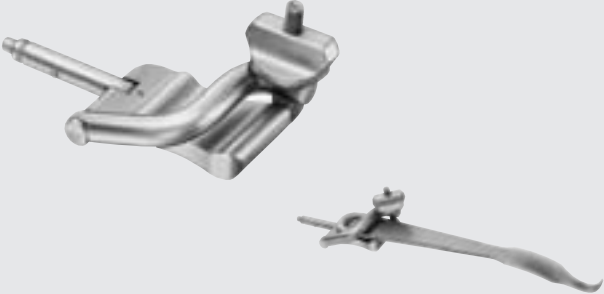

Universal holder Universalhalter	Order number Bestellnummer	Dimensions Maße
	RT071R	Holder for instruments with fenestrated handles Universalhalter für Wundhaken mit Gittergriff
	RT088R	Universal holder for bone levers Universalhalter für Knochenheber
	RT072R	Universal spatula holder for instruments with diam. 3-10 mm Universalhalter für Spatel und Instrumente mit Durchmesser 3-10 mm
	RT074R	Adapter for ball snap closure valves Universalhalter für Wundhakenblätter mit Kugelschnellverschluss

Holder for endoscopy  
Endoskophalter

Order number  
Bestellnummer

Diameter  
Durchmesser



RT081R

Adapter for endoscopes with  
diam. 10 mm, with PEEK insert  
RT086P  
Endoskophalter für Endoskope  
mit 10 mm Schaftdurchmesser  
kpl. mit PEEK Einsatz RT086P



RT082P  
RT083P  
RT084P  
RT085P  
RT086P  
RT089P  
RT094P

6.2 mm  
6.0 mm  
4.6 mm  
3.2 mm  
10.0 mm  
3.0 mm  
3.5 mm

Peek inserts for holding  
endoscopes for RT081R  
PEEK Einsätze zu RT081R



RT079R

Endoscope holder for fixation  
at the endoscope body or at  
the ocular, diameter 21 mm  
Endoskophalter, zur Fixierung  
am Endoskopkörper oder  
Okular, Durchmesser 21 mm

Holder for endoscopy  
Endoskophalter

Order number  
Bestellnummer

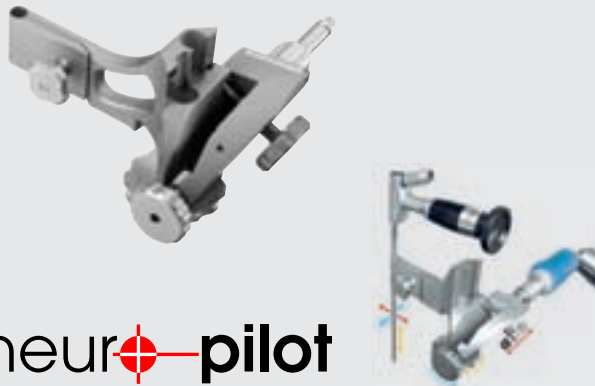

neur+pilot

RT060R

NeuroPilot IV+EA for intraventricular and endoscope-assisted indications with all Aesculap neuroendoscopes  
NeuroPilot IV+EA für intraventrikuläre Eingriffe und endoskop-assistierte Techniken mit allen Aesculap Neuroendoskopen



RT061R

Insert for angled neuroscopes PE486A - PE526A with diam. 4 mm  
Einsatz für Winkelneuroscope PE486A - PE526A mit Durchmesser 4 mm

RT062R

Insert for short ventriculoscope FF372R with diam. 6.2 mm  
Einsatz für kurzes Ventrikuloskop FF372R mit Durchmesser 6,2 mm

RT063R

Insert for MINOP® trocar FF397R with diam. 3.2 mm  
Einsatz für MINOP® Trokar FF397R mit Durchmesser 3,2 mm

RT064R

Insert for MINOP® trocars FF398R and FH601R with diam. 4.6 mm  
Einsatz für MINOP® Trokare FF398R und FH601R mit Durchmesser 4,6 mm

RT065R

Insert for MINOP® trocar FF399R with diam. 6.0 mm  
Einsatz für MINOP® Trokar FF399R mit Durchmesser 6,0 mm

RT066R

Insert for PaediScope PF010A with diam. 3 mm  
Einsatz für PaediScope PF010A mit Durchmesser 3 mm

Holder for endoscopy  
Endoskophalter

Order number  
Bestellnummer



RT059R

RT067P

NeuroPilot IV for intraventricular indications with the long Aesculap ventriculoscope FF370R  
NeuroPilot IV für intraventriculäre Eingriffe mit dem langen Aesculap Ventrikuloskop FF370R

Insert for long ventriculoscope FF370R with diam. 6.2 mm  
Einsatz für langes Ventrikuloskop FF370R mit Durchmesser 6,2 mm



neur+pilot



RT087R





RT093R

Trocar with ball joint and holding device with diam. 10 mm, length 110 mm  
Trokar mit Kugelgelenk und Adapter mit Durchmesser 10 mm, Länge 110 mm

Trocar with ball joint and holding device with diam. 5.5 mm, length 110 mm  
Trokar mit Kugelgelenk und Adapter mit Durchmesser 5,5 mm, Länge 110 mm

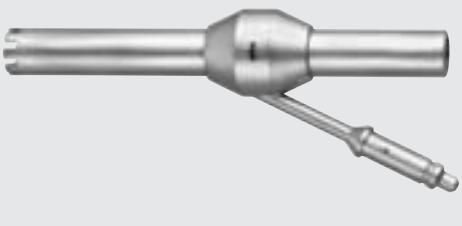
endofreeze

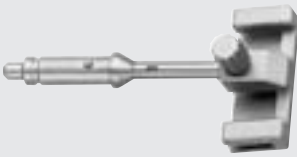

Special adapter Spezialadapter	Order number Bestellnummer	
	RT073R	Holder for Unitrac hooks and adapter Handgriff für Unitrac Wundhaken
 	RT075R	Holder for Vario Retractor BT800R Halter für Vario-Wundhaken BT800R
	RT076R	Holder for Vario Retractor BT799R Halter für Vario Wundhaken BT799R
	RT078R	Holder for Kirschner frame Halteung für Kirschner Rahmen
	RT020R	Quick connect adapter for use with sterile drape JG904 Schnellkupplung zur Verwendung mit dem Sterilüberzug JG904
not illustrated ohne Abbildung	JG904	Accessories • Ergänzendes Zubehör Sterile drape for additional coverage of the positioning arms, single-use product, package of 25 pcs. Sterilüberzug zur zusätzlichen Abdeckung der Haltearme, Einmalprodukt, Packung à 25 Stück

**Retractors with Unitrac connection**  
**Retraktoren mit Unitrac Anschluss**

**Order number**    **Blade dimensions**  
**Bestellnummer**    **Blattmaße**



RT110R    28 x 10 mm  
 RT111R    30 x 14 mm  
 RT112R    33 x 14 mm  
 RT113R    30 x 16 mm  
 RT114R    40 x 10 mm  
 RT115R    42 x 13 mm  
 RT117R    63 x 20 mm

[Langenbeck Retractor](#)  
 Langenbeck Retraktor



RT100R    28 x 15 mm  
 RT101R    25 x 15 mm  
 RT102R    38 x 15 mm  
 RT103R    42 x 15 mm

[US-Army Retractor](#)  
 US-Army Retraktor

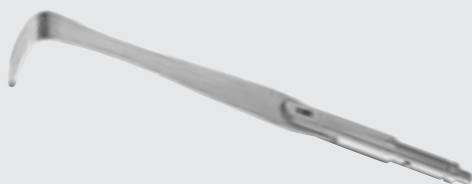

RT119R    26 x 6 mm  
 RT120R    35 x 8 mm  
 RT121R    35 x 11 mm  
 RT122R    35 x 15 mm  
 RT124R    55 x 11 mm

[Kocher-Langenbeck Retractor](#)  
 Kocher-Langenbeck Retraktor



RT136R    25 x 20 mm  
 RT137R    30 x 28 mm  
 RT138R    38 x 37 mm  
 RT139R    48 x 20 mm

[Richardson Retractor](#)  
 Richardson Retraktor



RT135R    21 x 15 mm

Kocher Retraktor  
[Kocher Retraktor](#)



**Retractors with Unitrac connection**  
**Retraktoren mit Unitrac Anschluss**

**Order number**  
**Bestellnummer**

**Blade dimensions**  
**Blattmaße**

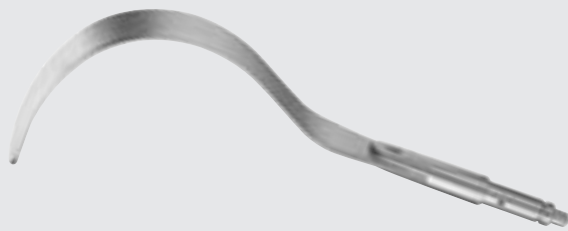

**RT165R**  
**RT166R**  
**RT167R**  
**RT168R**  
**RT169R**  
**RT170R**  
**RT171R**

226 x 24 mm  
238 x 25 mm  
219 x 38 mm  
227 x 50 mm  
181 x 25 mm  
240 x 25 mm  
228 x 75 mm

**Deaver Retractor**  
**Deaver Retraktor**



**RT176R**  
**RT177R**

52 x 80 mm  
80 x 80 mm

**Doyen Abdominal Retractor**  
**Doyen Retraktor**



**RT179R**  
**RT180R**

50 x 105 mm  
50 x 120 mm

**Rochard Abdominal Retractor**  
**Rochard Retraktor**



**RT174R**  
**RT175R**

50 x 105 mm  
50 x 120 mm

**Fritsch Retractor**  
**Fritsch Retraktor**

**Retractors with Unitrac connection**  
**Retraktoren mit Unitrac Anschluss**

Order number  
 Bestellnummer

Blade dimensions  
 Blattmaße



RT150R  
 RT151R  
 RT152R

85 x 35 mm  
 120 x 50 mm  
 155 x 50 mm

**Mikulicz Retractor**  
 Mikulicz Retraktor



RT144R  
 RT147R

120 x 25 mm  
 160 x 30 mm

**Brunner Retractor**  
 Brunner Retraktor



RT128R  
 RT129R

45 mm  
 60 mm

**Doyen Retractor**  
 Doyen Retraktor



**Retraktoren mit Unitrac Anschluss**  
**Retractors with Unitrac connection**

Order number  
Bestellnummer

Blade dimensions  
Blattmaße

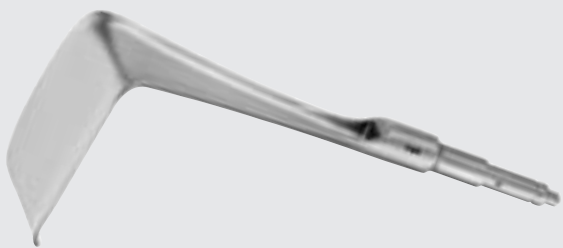

RT140R  
RT141R

63 x 50 mm  
70 x 63 mm

Kelly Retractor  
Kelly Retraktor



RT149R

160 x 38

Kelly Retractor  
Kelly Retraktor



RT157R  
RT158R

127 x 45 mm  
127 x 62 mm

Harrington Retractor  
Harrington Retraktor

**Retractors with Unitrac connection**  
**Retraktoren mit Unitrac Anschluss**

**Order number**  
**Bestellnummer**

**Blade dimensions**  
**Blattmaße**



**RT182R**

100 x 40 mm

**Kader Retractor**  
**Kader Retraktor**



**RT189R**  
**RT190R**  
**RT191R**

30 mm  
 40 mm  
 50 mm

**Abdominal Spatula, malleable**  
**Bauchspatel, biegsam**



**RT160R**  
**RT161R**

40 mm  
 53 mm

**Allison Lung spatula**  
**Allison Lungenspatel**







**RT153R**

115 x 65 mm

**Coryllos Retractor**  
**Coryllos Retraktor**

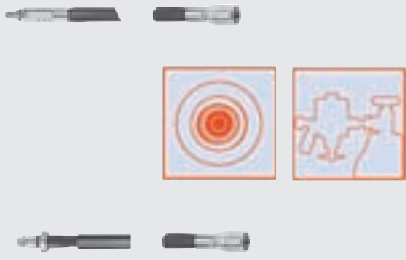

<b>Compressed-air hose system: Aesculap-Dräger</b> <b>Druckluftschlauch System: Aesculap – Dräger</b>	<b>Order number</b> <b>Bestellnummer</b>	<b>length</b> <b>Länge</b>
	GA460 GA464 GA466	3 m <b>combined spiral connection hose</b> Anschlussschlauch, spiralförmig 3 m <b>straight connection hose</b> Anschlussschlauch, gerade 5 m <b>straight connection hose</b> Anschlussschlauch, gerade
	RT035	2,2 m <b>Y-compressed air distributor, for connecting two UNITRAC® arms to one compressed air source.</b> <b>Must not be used with compressed air motors!</b> T-Verteilerschlauch, zum Anschluss von zwei Armen an eine Druckluftversorgung. Nicht geeignet für Druckluftmotoren!
<b>Druckluftschlauch System: Aesculap – Dräger</b> <b>Compressed-air hose system: Aesculap-Dräger</b>	<b>Order number</b> <b>Bestellnummer</b>	<b>length</b> <b>Länge</b>
	GA461 GA463 GA465	3 m <b>Connection hose with diffuser</b> Anschlussschlauch mit Diffusor 3 m <b>Connection hose without diffuser</b> Anschlussschlauch ohne Diffusor 5 m <b>Connection hose without diffuser</b> Anschlussschlauch ohne Diffusor
	GA468	5 m <b>Combined hose with SCHRADER coupling and diffuser</b> mit SCHRADER-Kupplung und Diffusor



# AESCULAP®

All it takes to operate.

distributed by:

USA

**AESCULAP INC.**

3773 Corporate Parkway  
Center Valley PA 18034  
Phone +1 650 624-5005  
Fax +1 610 231-3713  
[www.aesculap.com](http://www.aesculap.com)

United Kingdom

**B. Braun Medical Ltd.**

Thorncliffe Park  
Sheffield S35 2PW  
Phone +44 114 2259000  
Fax +44 114 2259111  
[www.bbraun.com](http://www.bbraun.com)

**B | BRAUN**  
SHARING EXPERTISE

**Aesculap AG & Co. KG**

Am Aesculap-Platz  
78532 Tuttlingen  
Phone +49 7461 95-0  
Fax +49 7461 95-2600  
[www.aesculap.de](http://www.aesculap.de)

All rights reserved. Technical alterations are possible. This leaflet may be used for no other purposes than offering, buying and selling of our products. No part may be copied or reproduced in any form. In the case of misuse we retain the rights to recall our catalogues and pricelists and to take legal actions.